

9

FERRAGENS PARA CABINES SANITÁRIAS **SANITARY BOOTH HARDWARE** HERRAJES PARA CABINAS SANITARIAS.

9.1
**FERRAGENS PARA
CABINES SANITÁRIAS /
SANITARY BOOTH HARDWARE /
HERRAJES PARA CABINAS
SANITARIAS.**

9.2
**AUXÍLIOS TÉCNICOS PARA
PESSOAS COM MOBILIDADE
CONDICIONADA /
TECHNICAL AID FOR PEOPLE WITH
CONDITIONED MOBILITY /
AYUDAS TÉCNICAS PARA
PERSONAS CON MOVILIDAD
ACONDICIONADA.**

9.3
**FERRAGENS PARA
CABINES EM HPL /
HPL PARTITIONS HARDWARE /
HERRAJES PARA CABINAS EN HPL.**





Wall dispenser L for paper towels

IN.60.556.L / Un.

Dispensador de parede com fechadura para toalhas de papel / Wall paper dispenser with lock for paper towels / Dispensador de pared con cerradura para toallas de papel.

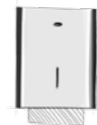

EN 1.4301 - AISI 304
Satinado / Satin

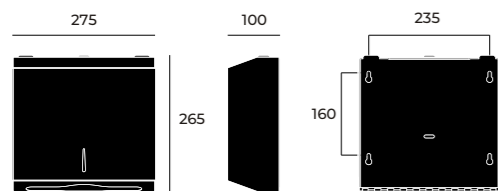

Wall dispenser XL for paper towels

IN.60.555 / Un.

Dispensador de parede com fechadura para toalhas de papel / Wall paper dispenser with lock for paper towels / Dispensador de pared con cerradura para toallas de papel.

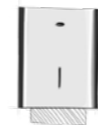

EN 1.4301 - AISI 304
Satinado / Satin

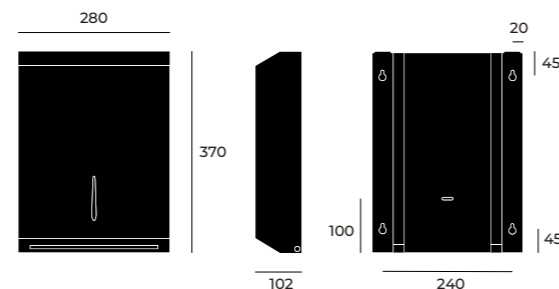

JUMBO wall dispenser for paper roll

IN.60.489 / Un.

Dispensador de parede JUMBO com fechadura para rolo de papel higiênico industrial / JUMBO Wall dispenser with lock for industrial paper roll. / Dispensador de pared JUMBO con cerradura para rollos de papel industrial.



EN 1.4301 - AISI 304
Satinado / Satin

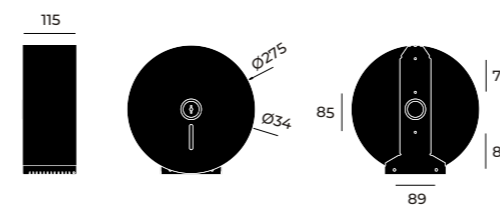

Hand dryer automatic 1800W

IN.60.546 / Un.

Secador de mãos automática / Automatic hand dryer / Secador de manos automático.



EN 1.4301 - AISI 304
Satinado / Satin



Tipo motor / motor type	1800w-2680rpm
Potência motor / motor power	60w
Nível ruído / noise level	67db
Velocidade ar / air speed	12m/s
Sensor / sensor range	50/200mm
isolamento / isolation	class 1

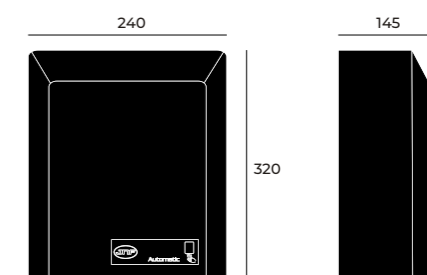

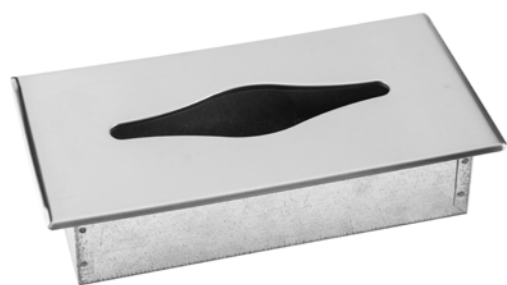

Paper towel dispenser satin finish

IN.60.551.E / Un.



Dispensador de toalhas de papel de embutir / Built-in paper towel dispenser / Dispensador de toallas de papel de embutir.

EN 1.4301 - AISI 304
Satinado / Satin

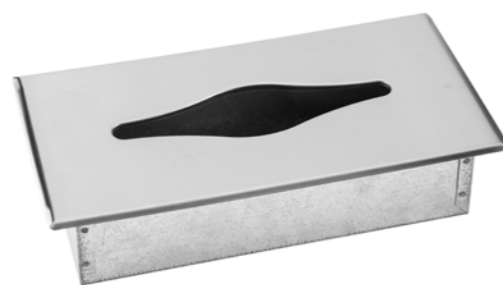
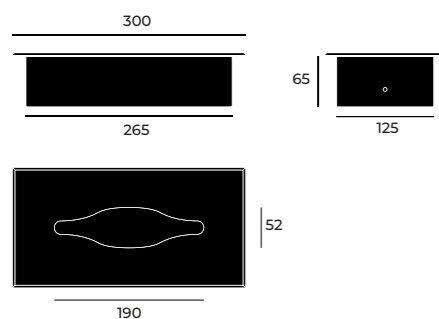

Paper towel dispenser mirror finish

IN.60.551.E.P / Un.



Dispensador de toalhas de papel de embutir / Built-in paper towel dispenser / Dispensador de toallas de papel de embutir.

EN 1.4301 - AISI 304
Polido / Polished / Pulido

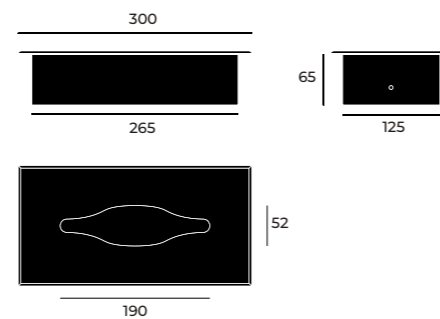

Embedded dispenser for liquid soap

IN.60.544 / Un.



Dispensador de sabão líquido encastrável / Embedded soap dispenser / Dispensador de jabón líquido encastrable.

EN 1.4301 - AISI 304
Satinado / Satin

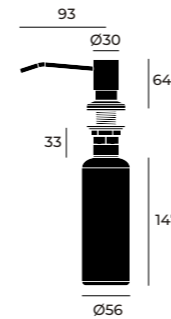



LED

x4
AA (6v)

MÁX.
0,9L

Automatic dispenser for liquid soap

IN.60.550 / Un.

Dispensador de sabão automático. Reservatório plástico com 900cc. Duração das baterias 25,000 ciclos ou 1 ano. Dose: 0,7-0,8cc (adequado para álcool gel, álcool líquido, sabonete líquido, desinfetantes para as mãos, iodo esterilizado e detergentes). Fácil manutenção / Automatic liquid soap dispenser. Plastic container with 900cc. Battery life 25,000 cycles or 1 year. Dose: 0,7-0,8CC. Easy maintenance / Dispensador de jabón automático. Recipiente de plástico con 900cc. Duración de la batería 25,000 ciclos o 1 año. Dosis: 0,7 - 0,8cc. Fácil mantenimiento.

EN 1.4301 - AISI 304
Satinado / Satin

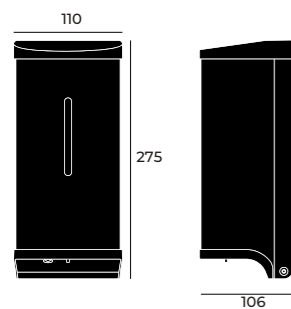



MÁX.
0,5L

Manual dispenser 0,5 L for liquid soap

IN.60.483.05 / Un.

*Dispensador de parede para sabão líquido.
Capacidade de 0,5L /
Wall dispenser for liquid soap. Capacity 0,5L /
Dispensador de pared para jabón líquido.
Capacidad 0,5L*

EN 1.4301 - AISI 304
Satinado / Satin

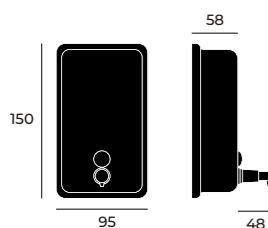

MÁX.
0,5L

Manual dispenser 0,5 L for liquid soap

IN.60.483.05.P / Un.

*Dispensador de parede para sabão líquido.
Capacidade de 0,5L /
Wall dispenser for liquid soap. Capacity 0,5L /
Dispensador de pared para jabón líquido.
Capacidad 0,5L*

EN 1.4301 - AISI 304
Polido / Polished / Pulido

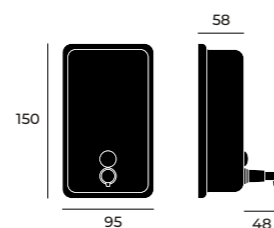

MÁX.
1L

Manual dispenser 1,0 L for liquid soap

IN.60.483.10 / Un.

*Dispensador de parede para sabão líquido.
Capacidade de 1,0L /
Wall dispenser for liquid soap. Capacity 1,0L /
Dispensador de pared para jabón líquido.
Capacidad 1,0L*

EN 1.4301 - AISI 304
Satinado / Satin

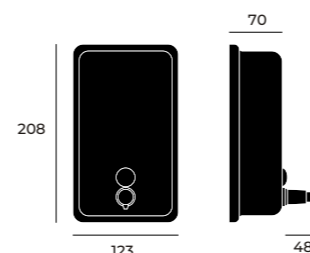

MÁX.
1L

Manual dispenser 1,0 L for liquid soap

IN.60.483.10.P / Un.

*Dispensador de parede para sabão líquido.
Capacidade de 1,0L /
Wall dispenser for liquid soap. Capacity 1,0L /
Dispensador de pared para jabón líquido.
Capacidad 1,0L*

EN 1.4301 - AISI 304
Polido / Polished / Pulido

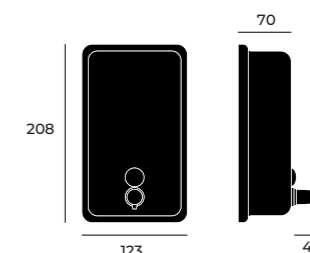

FREELINE

BY JNF

**YOUR FREEDOM
HARDWARE.****Ferragens para cabines sanitárias**
Sanitary booth hardware
Herrajes para cabinas sanitarias.

9.2

FREELINE

BY JNF

**FERRAGENS PARA CABINES SANITÁRIAS**
SANITARY BOOTH HARDWARE
HERRAJES PARA CABINAS SANITARIAS.**Auxílios técnicos para pessoas com
mobilidade condicionada / Technical
aid for people with conditioned mobility
/ Ayudas técnicas para personas con
movilidad acondicionada.**

9.2



A GAMA DE ACESSÓRIOS DE APOIO A PESSOAS COM MOBILIDADE CONDICIONADA ENCONTRAM-SE ABRANGIDA PELO DECRETO- LEI N.º 163/2006 DE 8 DE AGOSTO, O QUAL TEM POR OBJECTO A DEFINIÇÃO DAS CONDIÇÕES DE ACESSIBILIDADE A SATISFAZER NO PROJECTO E NA CONSTRUÇÃO DE ESPAÇOS PÚBLICOS, EDIFÍCIOS PÚBLICOS E HABITACIONAIS.

THE RANGE OF ACCESSORIES TO SUPPORT PEOPLE WITH REDUCED MOBILITY IS COVERED BY DECREE-LAW NO. 163/2006 OF 8 AUGUST, WHICH AIMS TO DEFINE THE ACCESSIBILITY CONDITIONS TO BE MET IN THE DESIGN AND CONSTRUCTION OF PUBLIC SPACES, PUBLIC BUILDINGS AND HOUSING.

A GAMA DE ACCESORIOS PARA AYUDAR A LAS PERSONAS CON MOVILIDAD REDUCIDA, ESTA AMPARADA POR EL DECRETO-LEY N.º 163/2006, DE 8 DE AGOSTO, QUE TIENE POR OBJETO DEFINIR LAS CONDICIONES DE ACCESIBILIDAD QUE DEBEN CUMPLIRSE EN EL DISEÑO Y CONSTRUCCIÓN DE ESPACIOS PÚBLICOS, EDIFICIOS PÚBLICOS Y VIVIENDAS.

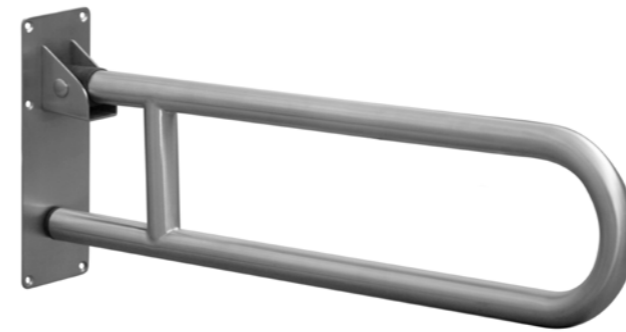
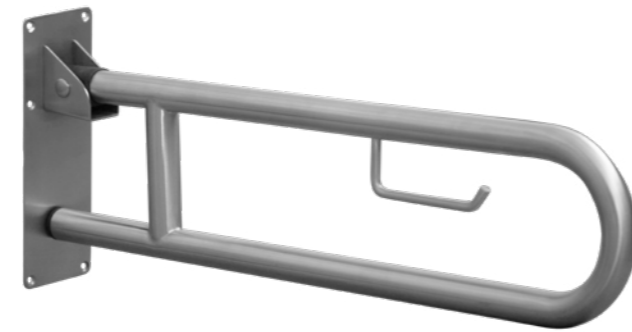

new

Folding safety support with paper holder

IN.12.020 / Un.



Barra de apoio rebatível com porta
rolo / Folding safety support with paper
holder / Barra de apoyo rebatible con
soporte de papel.

EN 1.4301 - AISI 304
Satinado / Satin

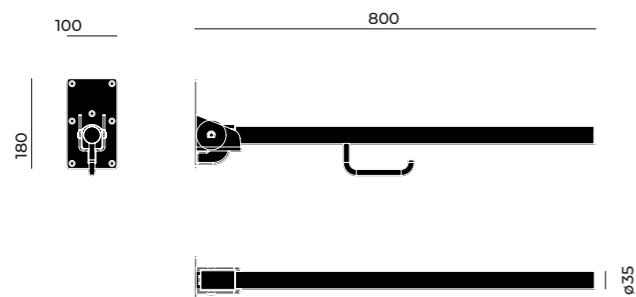

Folding safety support with paper holder

IN.12.002 / Un.



Barra de apoio rebatível com porta
rolo / Folding safety support with paper
holder / Barra de apoyo rebatible con
soporte de papel.

EN 1.4301 - AISI 304
Satinado / Satin

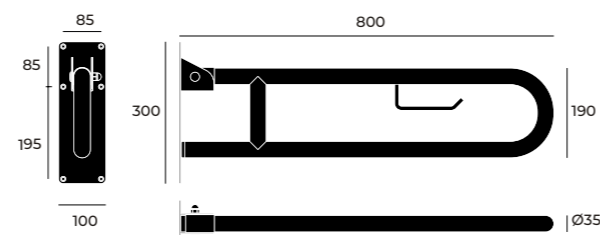
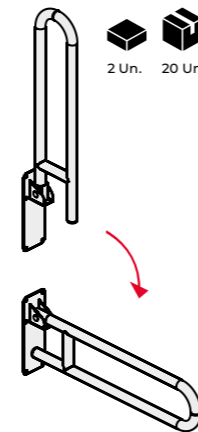

Folding safety support hold open position

IN.12.022 / Un.



Barra de apoio rebatível /
Folding safety support /
Barra de apoyo rebatible.

EN 1.4301 - AISI 304
Satinado / Satin

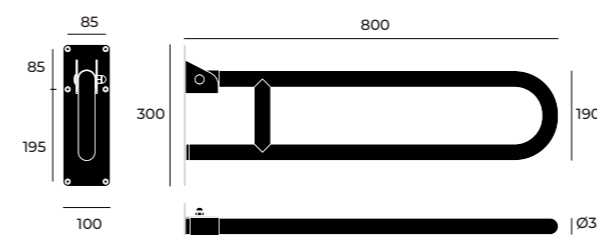
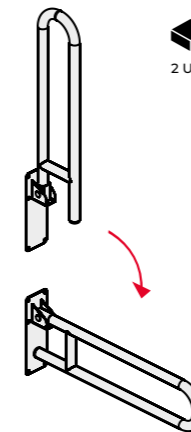

Wall safety support horizontal 90°

IN.12.029 / Un.



Barra de apoio de parede /
Wall safety support /
Barra de apoyo de pared

EN 1.4301 - AISI 304
Satinado / Satin

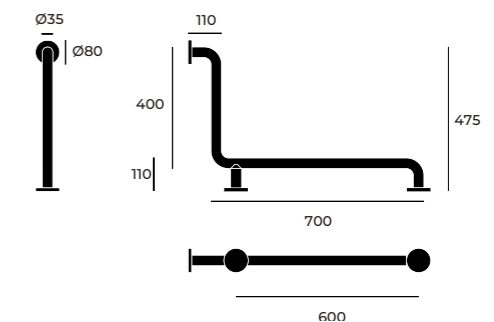



Wall safety support right hand $\varnothing 35$

IN.12.009.D / Un.
(Direita / Right / Derecha)



*Barra de apoio de parede /
Wall safety support /
Barra de apoyo de pared.*

EN 1.4301 - AISI 304
Satinado / Satin

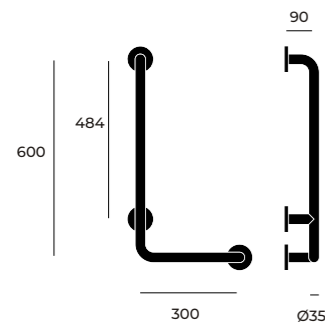

Wall safety support left hand $\varnothing 35$

IN.12.009.E / Un.
(Esquerda / Left / Izquierda)



*Barra de apoio de parede /
Wall safety support /
Barra de apoyo de pared.*

EN 1.4301 - AISI 304
Satinado / Satin

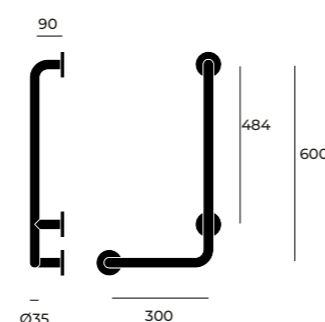

Wall safety support 90 degrees $\varnothing 35$

IN.12.010 / Un.



*Barra de apoio de parede /
Wall safety support /
Barra de apoyo de pared.*

EN 1.4301 - AISI 304
Satinado / Satin

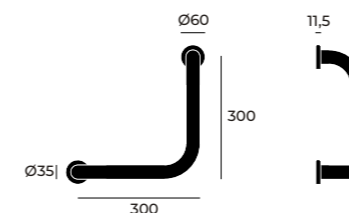

Wall safety support 135 degrees $\varnothing 35$

IN.12.011 / Un.



*Barra de apoio de parede
Wall safety support /
Barra de apoyo de pared*

EN 1.4301 - AISI 304
Satinado / Satin

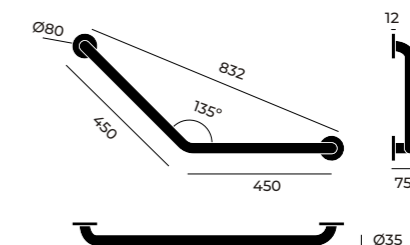

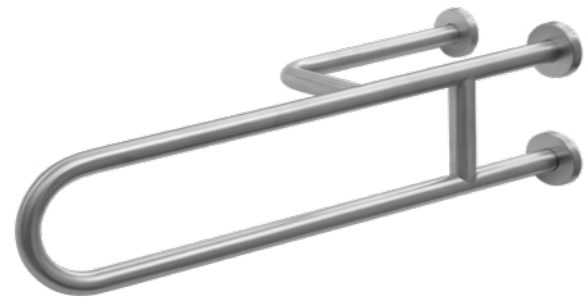

Wall safety support right hand $\varnothing 35$

IN.12.003.D / Un.
(Direita / Right / Derecha)



*Barra de apoio de parede /
Wall safety support /
Barra de apoyo de pared.*

EN 1.4301 - AISI 304
Satinado / Satin

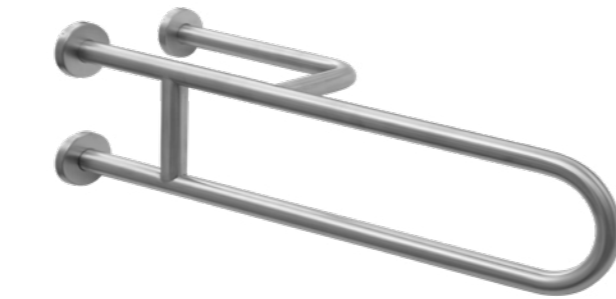
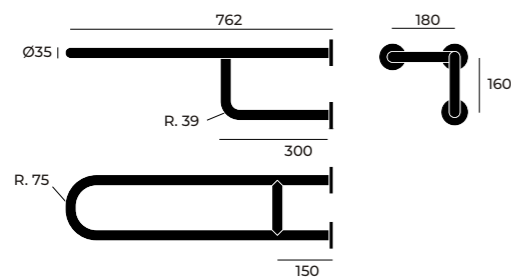

Wall safety support left hand $\varnothing 35$

IN.12.003.E / Un.
(Esquerda / Left / Izquierda)



*Barra de apoio de parede /
Wall safety support /
Barra de apoyo de pared.*

EN 1.4301 - AISI 304
Satinado / Satin

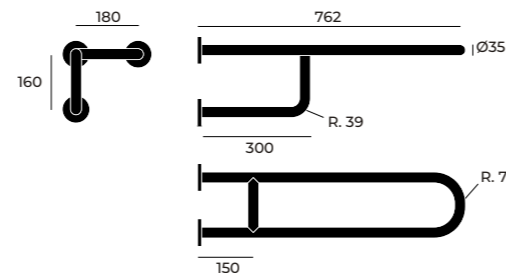

Wall and floor support right hand $\varnothing 35$

IN.12.015.D / Un.
(Direita / Right / Derecha)



*Barra de apoio de parede /
Wall safety support /
Barra de apoyo de pared.*

EN 1.4301 - AISI 304
Satinado / Satin

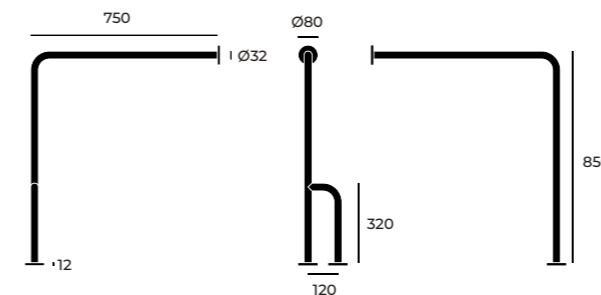

Wall and floor support left hand $\varnothing 35$

IN.12.015.E / Un.
(Esquerda / Left / Izquierda)



*Barra de apoio de parede /
Wall safety support /
Barra de apoyo de pared.*

EN 1.4301 - AISI 304
Satinado / Satin

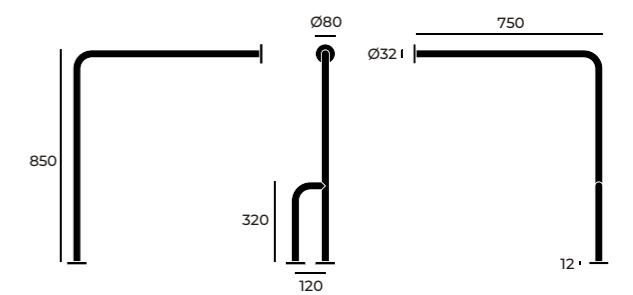



Wall safety support

Ø35 - c.c.425mm

IN.12.025 / Un.



Barra de apoio de parede / Wall safety support / Barra de apoyo de pared.

EN 1.4301 - AISI 304
Satinado / Satin

Wall safety support

Ø35 - c.c.600mm

IN.12.026 / Un.



Barra de apoio de parede / Wall safety support / Barra de apoyo de pared.

EN 1.4301 - AISI 304
Satinado / Satin

Wall safety support

Ø35 - c.c.800mm

IN.12.027 / Un.



Barra de apoio de parede / Wall safety support / Barra de apoyo de pared.

EN 1.4301 - AISI 304
Satinado / Satin

Wall safety support

Ø35 - c.c.1000mm

IN.12.028 / Un.



Barra de apoio de parede / Wall safety support / Barra de apoyo de pared.

EN 1.4301 - AISI 304
Satinado / Satin

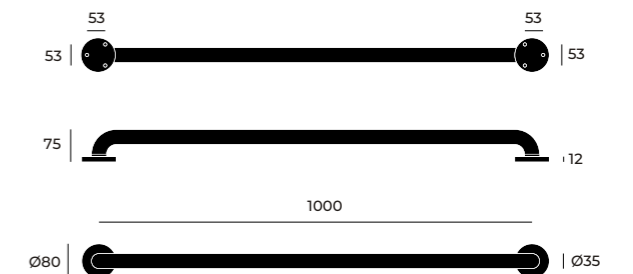
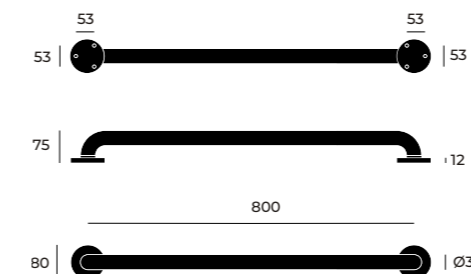
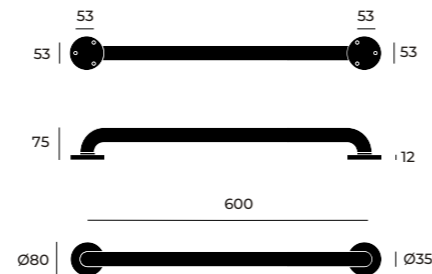
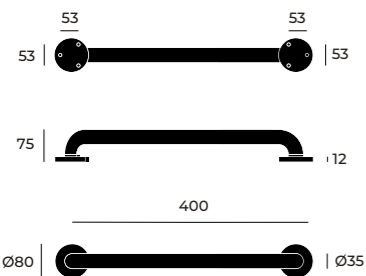

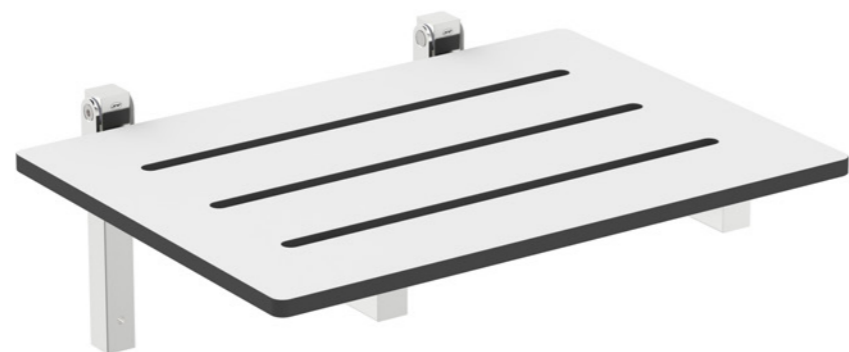

HPL

Folding bathroom seat 500

HPL white surface + black core

IN.12.044 / Un.

*Banco para WC (base em resina fenólica) /
Bathroom seat (phenolic resin base) /
Asiento para baño (base en resina fenolica).*

EN 1.4301 - AISI 304
Satinado / Satin

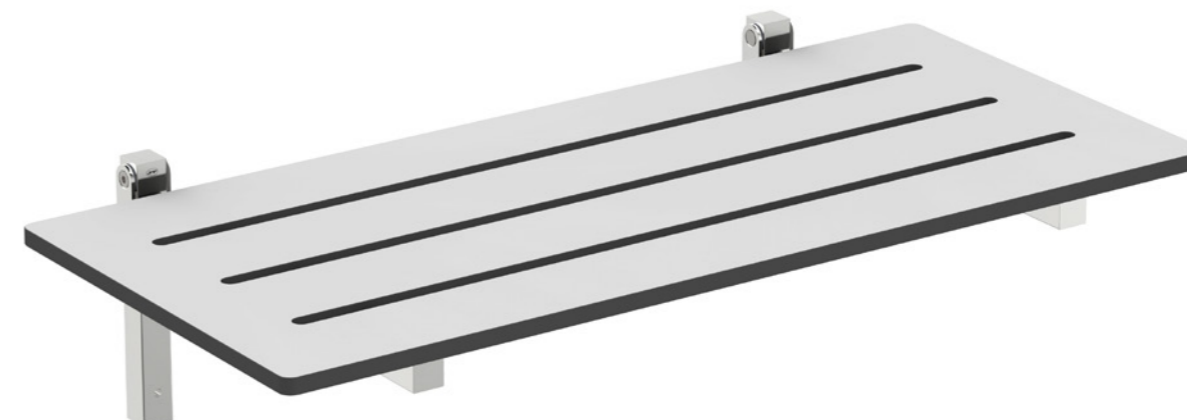
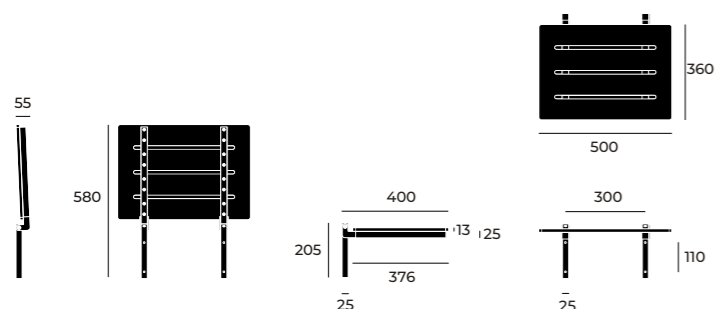

HPL

Folding bathroom seat 800

HPL white surface + black core

IN.12.045 / Un.

*Banco para WC (base em resina fenólica) /
Bathroom seat (phenolic resin base) /
Asiento para baño (base en resina fenolica).*

EN 1.4301 - AISI 304
Satinado / Satin



(*)
Regulamentos de discriminação por deficiência (DDA) /
Disability discrimination act (DDA) / Normativa sobre discriminación por discapacidad.

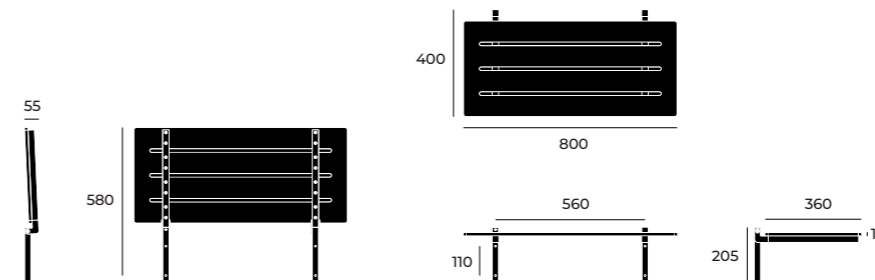

FREELINE

BY JNF



YOUR FREEDOM
HARDWARE.

Ferragens para cabines sanitárias
Sanitary booth hardware
Herrajes para cabinas sanitarias.

9.3

FREELINE

BY JNF



FERRAGENS PARA CABINES SANITÁRIAS
SANITARY BOOTH HARDWARE
HERRAJES PARA CABINAS SANITARIAS.

Ferragens para cabines em HPL /
HPL partitions hardware /
Herrajes para cabinas en HPL.

9.3

HPL PARTITIONS HARDWARE

FERRAGENS PARA CABINES EM HPL |
HERRAJES PARA CABINAS EN HPL.





HPL

ECO series

Ø25

Adjustable feet for HPL

Ø25mm

SM.025 / Un.



Base regulável para painel /
Adjustable foot /
Pie regulable.

EN 1.4301 - AISI 304
Satinado / Satin

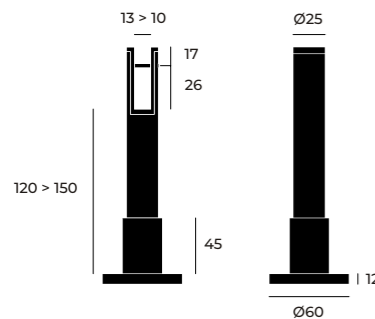

HPL

ECO series

Ø25

Connector tube to HPL

Ø25mm

SM.002.ECO / Un.



Suporte superior para painel /
Upper panel holder /
Soporte superior para panel.

EN 1.4301 - AISI 304
Satinado / Satin

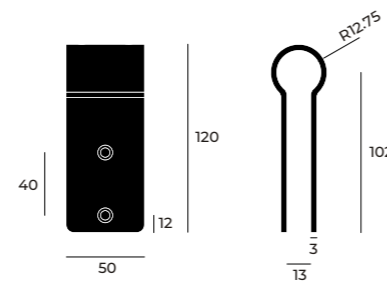

HPL

Ø25

Connector tube to HPL

Ø25mm

SM.012.180 / Un.



Suporte superior para painel /
Upper panel holder /
Soporte superior para panel.

EN 1.4301 - AISI 304
Satinado / Satin

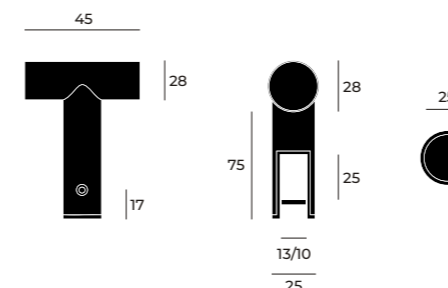

HPL

Ø25

Connector tube to HPL

Ø25mm

SM.012.90 / Un.



Suporte superior para painel /
Upper panel holder /
Soporte superior para panel.

EN 1.4301 - AISI 304
Satinado / Satin

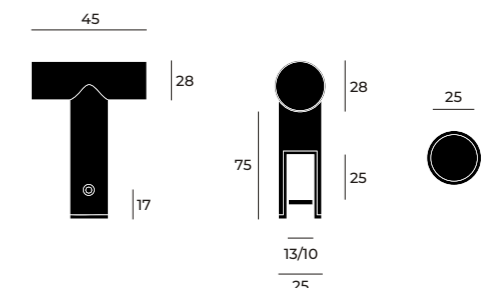



HPL

Ø25

Tube connector for HPL Ø25mm

SM.015 / Un.



União de tubo a 90° para tubo de Ø25mm /
Tube connector at 90° for Ø25mm tube /
Unión de tubo a 90° para tubo de Ø25mm

EN 1.4301 - AISI 304
Satinado / Satin

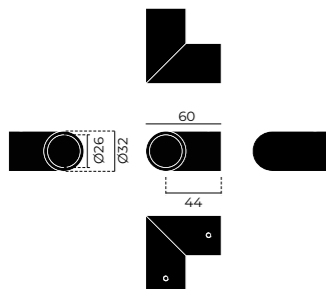

Ø25

Tube Ø25mm

SM.010.A.25.2000 / Un.
SM.010.A.25.3000 / Un.
SM.010.A.25.6000 / Un.



Tubo de Ø25 com 2000mm, 3000mm e 6000mm /
Ø25 tube with 2000mm, 3000mm and 6000mm /
Tubo Ø25 con 2000mm, 3000mm y 6000mm.

EN 1.4301 - AISI 304
Satinado / Satin

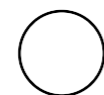

Ø25 x 1,2mm



2000 / 3000 / 6000





Ø25

Two way connector Ø25mm

SM.032.25 / Un.



União de tubo a 90° para tubo Ø25mm /
Tube connector at 90° for Ø25mm tube /
Union de tubo a 90° para tubo de Ø25mm.

EN 1.4301 - AISI 304
Satinado / Satin

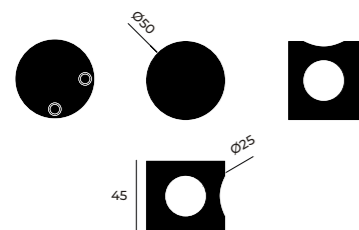

Ø25

Connector tube-tube Ø25mm

SM.010.C.25 / Un.



Conector para tubo Ø25mm /
Tube connector Ø25mm /
Conector para tubo Ø25mm

Alumínio /
Aluminium / Aluminio

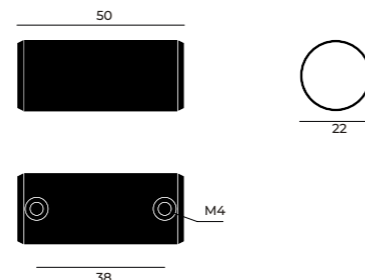

Ø25

Tube wall support Ø25mm

SM.011.25 / Un.



Suporte de tubo com fixação à parede /
Wall mounting tube support /
Soporte de tubo con sujeción a pared.

EN 1.4301 - AISI 304
Satinado / Satin

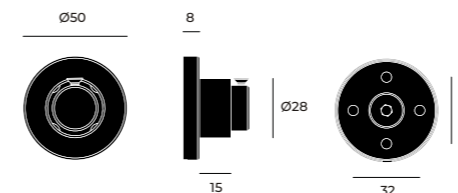

Ø25

Three way connector Ø25mm

SM.033.25 / Un.



União de tubo a 90° e 180°
para tubo de Ø25mm /
Tube connector at 90° and 180°
for Ø25mm /
Union de tubo a 90° y 180°
para tubo de Ø25mm.

EN 1.4301 - AISI 304
Satinado / Satin

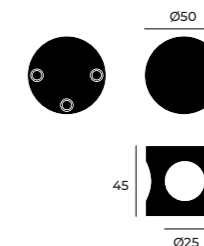



HPL

Ø25

Double L support for HPL boards

SM.014 / Un.



*Suporte para painel /
Panel holder /
Soporte para panel.*

EN 1.4301 - AISI 304
Satinado / Satin

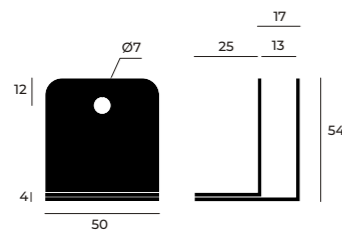

HPL

Ø25

T Panel support for HPL boards

SM.034 / Un.



*Suporte para painel /
Panel holder /
Soporte para panel.*

EN 1.4301 - AISI 304
Satinado / Satin

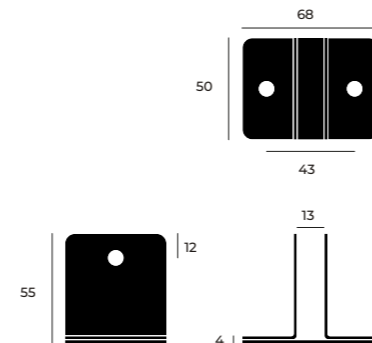

HPL

Ø25

L Panel support for HPL boards

SM.044 / Un.



*Suporte para painel /
Panel holder /
Soporte para panel.*

EN 1.4301 - AISI 304
Satinado / Satin

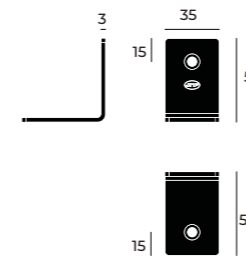

HPL

Ø25

L Panel support for HPL boards

SM.004 / Un.



*Suporte para painel /
Panel holder /
Soporte para panel.*

EN 1.4301 - AISI 304
Satinado / Satin

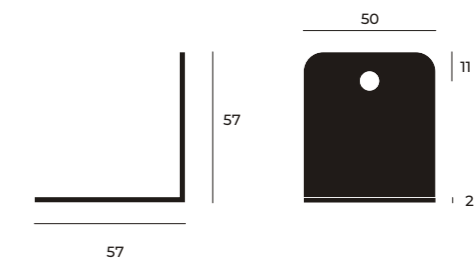



U Panel support for HPL boards

SM.024 / Un.



Suporte para painel /
Panel holder /
Soporte para panel.

EN 1.4301 - AISI 304
Satinado / Satin

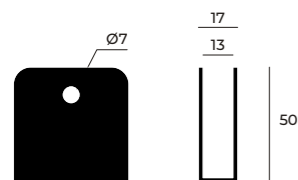

Reinforced U profile in aluminium for HPL

SM.103 / Un.



Perfil em "U" para painel até 13mm
"U" shape profile until 13mm panel /
Perfil en "U" para panel de 13mm.

Alumínio /
Aluminium / Aluminio

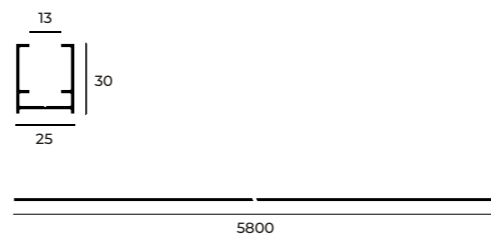

U profile for HPL panel in aluminium

SM.101.AL.3000 / Un.
SM.101.AL.6000 / Un.



Perfil em "U" para painel até 13mm com
3000mm ou 6000mm.

"U" shape profile until 13mm panel with
3000mm and 6000mm /
Perfil en "U" para panel de 13mm con
3000mm ou 6000mm.

Alumínio /
Aluminium / Aluminio

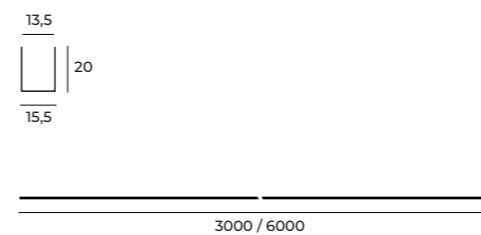

Double door knob for HPL

IN.75.030 / Un.



Puxador para portas de vidro ou fenólico /
Knobs for glass or phenolic doors /
Pomos para puerta de cristal o fenolico.

EN 1.4301 - AISI 304
Satinado / Satin

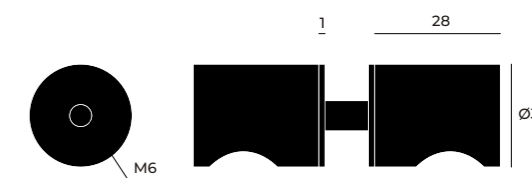



HPL

Double door knob anti-vandalism

SM.019 / Un.

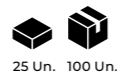

*Puxador de porta duplo anti-vandalismo /
Double door knob with anti-vandalism fixing /
Tirador de puerta doble anti-vandalismo.*

EN 1.4301 - AISI 304
Satinado / Satin

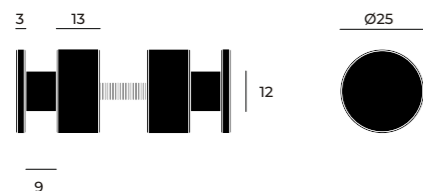

HPL

Double door knob anti-vandalism

SM.020 / Un.



*Puxador de porta duplo anti-vandalismo /
Double door knob with anti-vandalism fixing /
Tirador de puerta doble anti-vandalismo.*

EN 1.4372 - AISI 201
Satinado / Satin

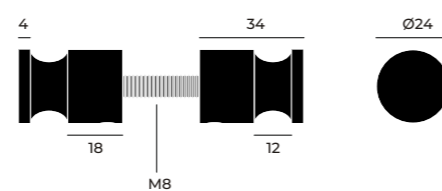

The 1st one bathroom latch

SM.026 / Un.



*Fecho para wc com indicador
de cor (livre-ocupado) /
Bathroom latch with color indicator
(vacant - occupied) /
Cierre de baño con indicador
(libre - ocupado).*

EN 1.4301 - AISI 304
Satinado / Satin

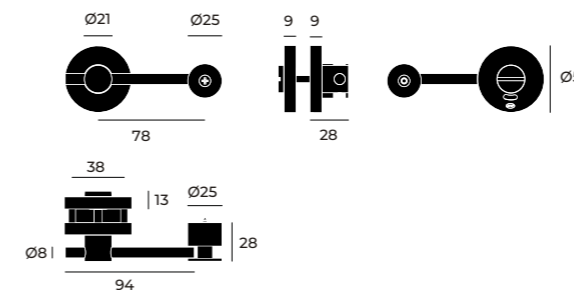

Bathroom latch with hook

SM.027 / Un.



*Fecho para wc para portas de correr
com indicador de cor (livre-ocupado) /
Bathroom latch for sliding doors with
color indicator (vacant - occupied) /
Cerradura de baño para puertas correderas
con indicador de color (libre-ocupado).*

EN 1.4301 - AISI 304
Satinado / Satin

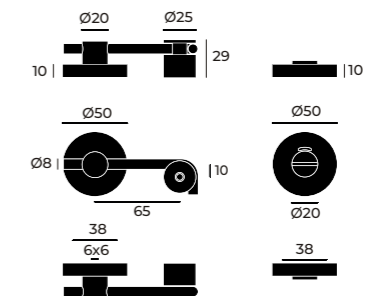



Snib indicator bolt with sliding lever

IN.17.616 / Un.



Fecho com indicador de cor.
Espessura 12-35mm |
Slide bolt with color indicator.
Thickness 12-35mm |
Cierre con indicador de color.
Espesor 12-35mm.

EN 1.4301 - AISI 304
Satinado / Satin

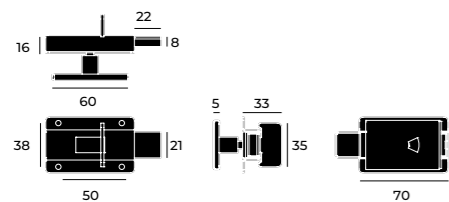

Bathroom latch with indicator

SM.02039 / Set



*Fecho para wc com indicador
de cor (livre-ocupado) /*
Bathroom latch with color
indicator (vacant - occupied) /
Cierre de baño con indicador
(libre - ocupado)

ZAMAK - cor inox /
Zamak - inox color / ZAMAK - color acero inoxidable

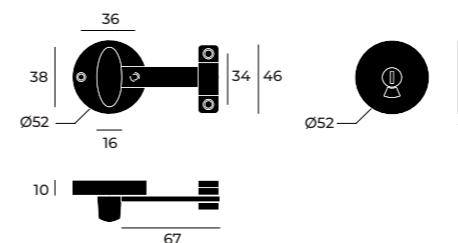

Bolt with sliding lever surface mounting

IN.17.617 / Un.



Fecho de sobrepor com alavanca deslizante /
Surface mounting bolt with sliding lever |
Pasador de sobreponer con leva deslizante.

EN 1.4301 - AISI 304
Satinado / Satin

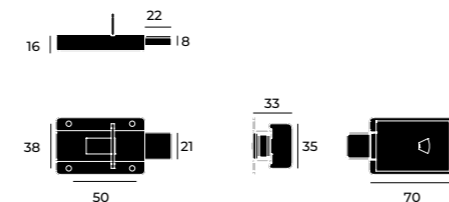

Bathroom latch with indicator

SM.051 / Set



*Fecho para wc com indicador
de cor (livre-ocupado) /*
Bathroom latch with color indicator
(vacant - occupied) /
Cierre de baño con indicador
(libre - ocupado)

EN 1.4301 - AISI 304
Satinado / Satin

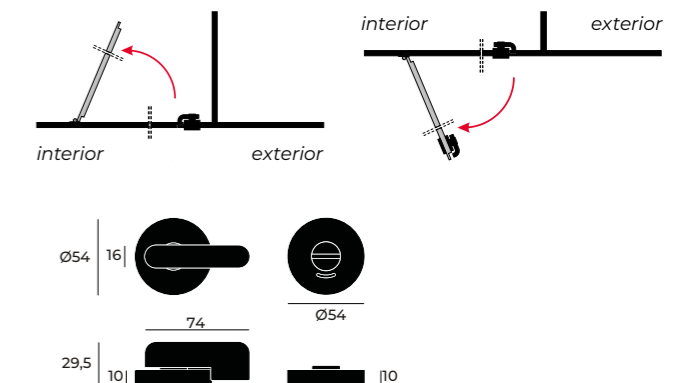

HPL HINGES WITH COVERS

DOBRADIÇAS PARA HPL COM TAMPAS /
BISAGRAS PARA HPL CON CUBIERTAS.



x3
20 Kg

HPL

Spring hinge for HPL with concealed fixings

SM.005.E / Un.



Dobradiça para HPL com mola
ajustável e fixações ocultas.
Parafusos incluídos /
Adjustable spring hinge for HPL with
concealed fixings. Screws included /
Bisagra para HPL con resorte ajustable y
fijaciones ocultas. Tornillos incluidos.

EN 1.4301 - AISI 304
Satinado / Satin

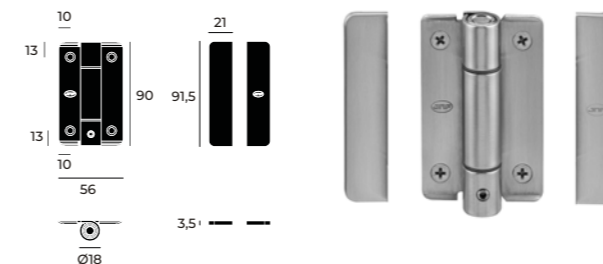

x3
20 Kg

HPL

Hinge for HPL with concealed fixings

SM.005.F / Un.



Dobradiça para HPL com fixações
ocultas. Parafusos incluídos /
Hinge for HPL with concealed fixings.
Screws included /
Bisagra para HPL con fijaciones ocultas.
Tornillos incluidos

EN 1.4301 - AISI 304
Satinado / Satin

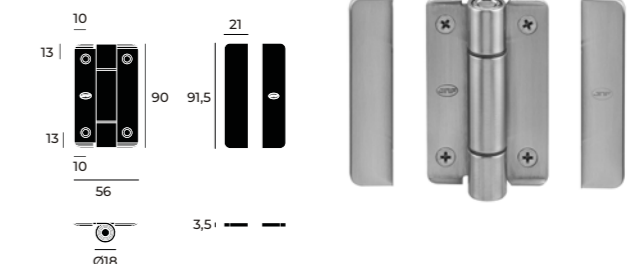



HPL

HPL Cabinet flat hinge reversible with spring

SM.005.C / Un.



Dobradiça de sobrepor com mola para auto-fecho. Reversível. Mola com força ajustável /

Flat hinge to overlap with spring for self closing. Reversible. Spring with power adjustment /
Bisagra plana de sobreponer con muelle para autocierre. Reversible. Muelle con ajuste de fuerza.

EN 1.4372 - AISI 201
Satinado / Satin

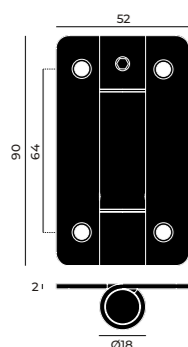

HPL

HPL Cabinet flat hinge reversible without spring

SM.005.B / Un.



Dobradiça de sobrepor. Reversível /
Flat hinge to overlap. Reversible /
Bisagra plana de sobreponer. Reversible.

EN 1.4372 - AISI 201
Satinado / Satin

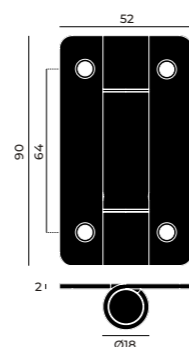

HPL

HPL Cabinet flat hinge reversible

SM.005.D.ECO / Un.



Dobradiça de sobrepor. Reversível /
Flat hinge to overlap. Reversible /
Bisagra plana de sobreponer. Reversible.

EN 1.4372 - AISI 201
Satinado / Satin

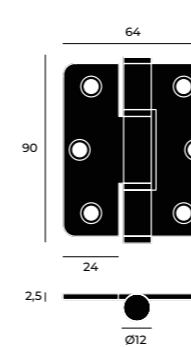

HPL

HPL Cabinet flat hinge reversible

SM.005.A.ECO.D / Un.
(Direita / Right / Derecha)
SM.005.A.ECO.E / Un.
(Esquerda / Left / Izquierda)



Dobradiça de sobrepor /
Flat hinge to overlap /
Bisagra plana de sobreponer.

EN 1.4372 - AISI 201
Satinado / Satin

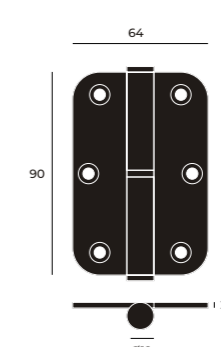



Boat hook P1

hook AISI 316

IN.14.546.F / Un.



Cabide | Hook | Percha

EN 1.4401 - AISI 316
Satinado / Satin

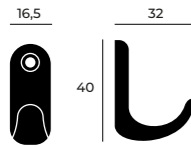

Boat hook P2

hook AISI 316

IN.14.546 / Un.



Cabide | Hook | Percha

EN 1.4401 - AISI 316
Satinado / Satin

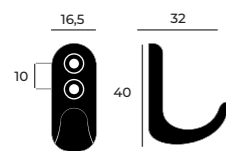

480



Hang

hook

IN.14.030 / Un.



Cabide | Hook | Percha

EN 1.4301 - AISI 304
Satinado / Satin

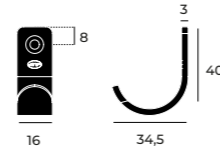

You need me

hook

IN.14.010 / Un.



Cabide | Hook | Percha

EN 1.4301 - AISI 304
Satinado / Satin

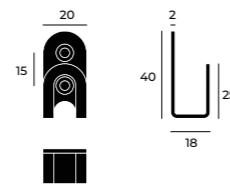

Cabinet hook

double hook

IN.14.530.ECO / Un.



Cabide duplo | Double hook | Percha doble.

EN 1.4301 - AISI 304
Satinado / Satin

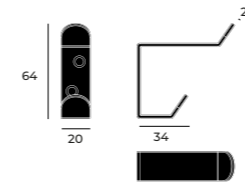

Cabinet hook + stopper

double function

IN.14.529.ECO / Un.



Cabide duplo com batente de porta |
Double hook with door stopper |
Percha doble con tope de puerta.

EN 1.4301 - AISI 304
Satinado / Satin

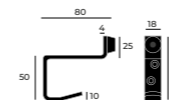

Cabinet hook + stopper

double function

SM.008 / Un.



Cabide com batente de porta |
Hook with door stopper |
Percha con tope de puerta.

EN 1.4301 - AISI 304
Satinado / Satin

